

MKE 400

Bedienungsanleitung
Instructions for use
Notice d'emploi
Istruzioni per l'uso
Instrucciones de uso
Gebruiksaanwijzing

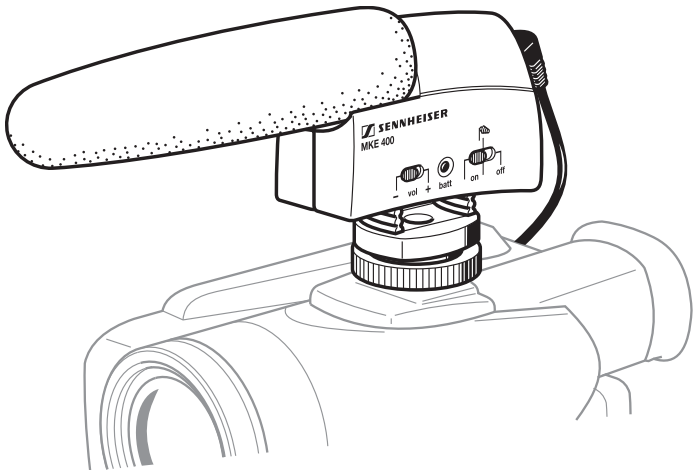

The MKE 400

Important safety information

Keep liquids (such as rain, etc.) away from the microphone!

Features

- Rugged all-metal housing
- Maximal rejection of side noise, designed for use on film and video cameras/camcorders
- Volume switch adjusts the sensitivity to cope with varying distances from the sound source
- Switchable low-cut filter minimizes wind noise
- More than 300 hours operating time (with only one AAA size battery)
- Integrated shock mount ensures effective suppression of handling and camera noise

Operating elements

- 1 Microphone with removable windshield
- 2 "vol" switch
- 3 "batt" LED
- 4 "on/off" switch
- 5 Flashmount adapter with mounting thread
- 6 Knurled washer
- 7 Battery compartment catch

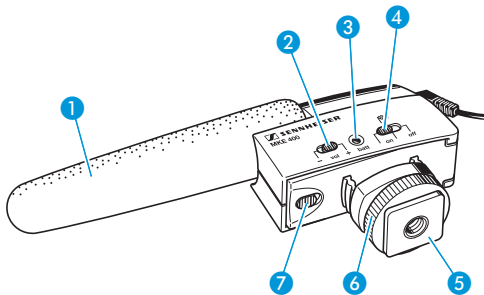

Delivery includes

- 1 MKE 400 camera/camcorder microphone with connection cable (3.5 mm stereo jack plug)
- 1 AAA size battery
- 1 foam windshield

Inserting/replacing the battery

If the battery voltage is sufficient, the “batt” LED ③ flashes briefly when you switch on the microphone. A new, unused battery has an operating time of approx. 300 hours.

When the battery voltage decreases, the “batt” LED ③ lights up permanently. You should replace the battery. When the “batt” LED ③ lights up permanently for the first time, the remaining operating time is approx. 50 hours.

Note: When not using the microphone for extended periods of time, remove the battery from the battery compartment!

To insert or replace the battery:

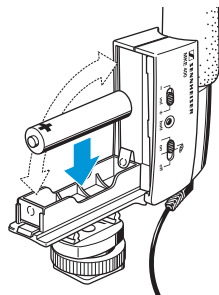

- ▶ Push the catch of the battery compartment ⑦ in the direction of the flashmount adapter and open the battery compartment.
- ▶ Insert the AAA size battery as shown in the diagram on the right. Observe correct polarity when inserting the battery.
- ▶ Close the battery compartment until the catch ⑦ locks into place.



Putting the microphone into operation

- ▶ Slide the microphone onto the video camera's flashmount and lock the microphone by screwing down the knurled washer ⑥.
- ▶ Insert the 3.5 mm stereo jack plug into the microphone input socket of the video camera.

- ▶ Switch the microphone on by setting the “on/off” switch ④ to one of the two positions:



“on/off”	Setting
	switched on (linear frequency response)
	switched on (low-cut filter is activated for minimizing wind noise)

On switch-on, the “batt” LED ③ flashes briefly, indicating that the battery is operational.

Note: When you have finished using the microphone, it is vital that you switch it off by setting the “on/off” switch ④ to the “off” position!



- ▶ Adjust the microphone sensitivity to the volume of the sound source and to the input sensitivity of the camera/camcorder by setting the “vol” switch ② to the correct position:

“vol”	Setting
	Normal sensitivity: for normal or very loud sound sources and cameras/ camcorders with high input sensitivity
	High sensitivity: for extremely quiet or very distant sound sources and cameras/camcorders with low input sensitivity

Specifications

	"vol" switch in position –	"vol" switch in position +
Dimensions (W x H x D)	approx. 130 x 21 x 62 mm	
Weight (without battery)	approx. 60 g	
Pick-up pattern	super-cardioid/lobar	
Frequency response	40 Hz to 20 kHz with and without windshield	
Sensitivity	8 mV/Pa	20 mV/Pa
Max. sound pressure level	126 dB	118 dB
Equivalent noise level	21 dB (A), 32 dB (CCIR)	16 dB (A), 25 dB (CCIR)
Power supply	1.5 V AAA size battery	
Operating time	approx. 300 hours	
Helical cable	length: approx. 200 mm diameter: 2.3 mm with 3.5 mm stereo jack plug	

Recommended accessory

Professional accessory kit MZW 400 including hairy cover and 3-pin XLR adapter

Manufacturer declarations

Warranty

2 years

Approval

 Sennheiser electronic GmbH & Co. KG declare that this device is in compliance with the applicable CE standards and regulations.

Batteries or rechargeable batteries



Please dispose of batteries or rechargeable batteries as special waste or return them to your specialist dealer.

WEEE Declaration



Please dispose of this product at the end of its operational lifetime by bringing it to your local collection point or recycling centre for such equipment.

Frequenzkurve und Richtdiagramm

Frequency response and polar pattern

Réponse en fréquence et diagramme de la directivité

Risposta in frequenza e diagramma polare

Respuesta en frecuencia y diagrama de la directividad

Frequentie-ingangen en Pooldiagram

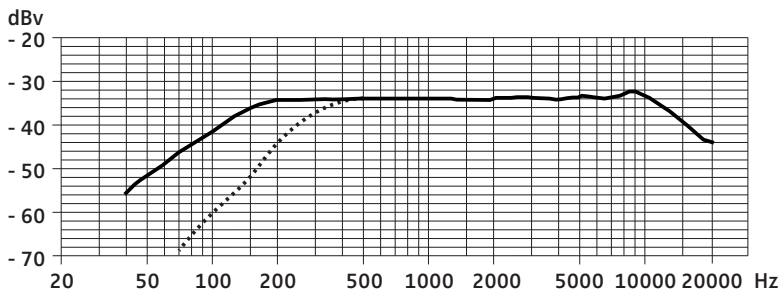

.....  Low Cut Filter

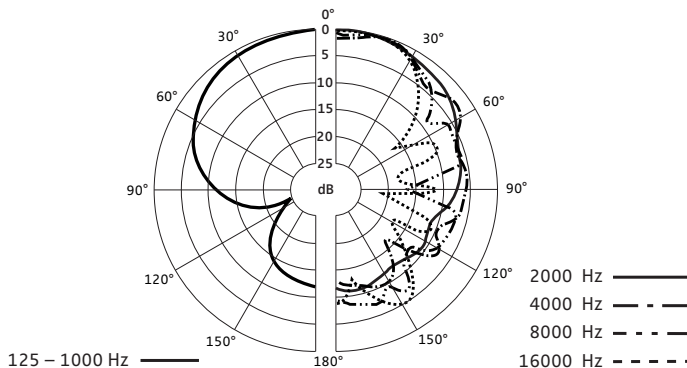



Sennheiser electronic GmbH & Co. KG
30900 Wedemark, Germany
Phone +49 (5130) 600 0
Fax +49 (5130) 600 300
www.sennheiser.com

Printed in Germany

Publ. 06/07

516599/A2